

Impellar Liquid Pump Range

Overview

The TCS M3000 Micropump is a high performance, high-quality miniature pump for liquids. It is efficient, small and lightweight. The solid construction and wide temperature tolerance, enables it to perform reliably even in hostile environments. Your Micropump can be quickly and easily installed into the smallest spaces, in a vast range of laboratory, prototype and production equipment.

Pump Variants

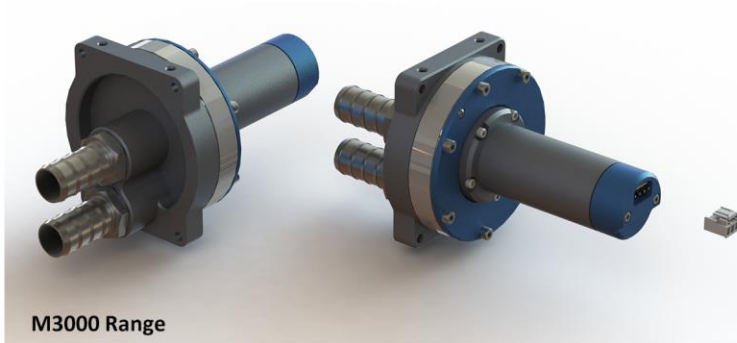

M3000 Range

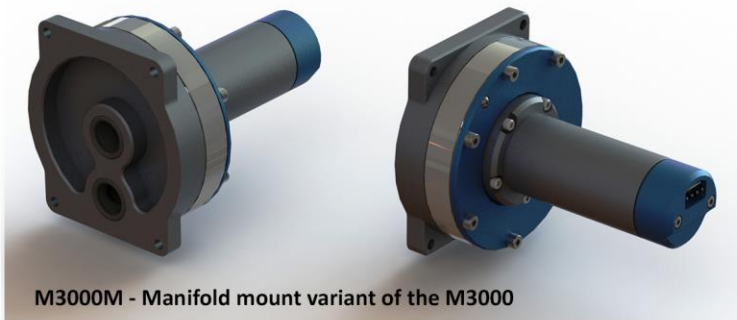

M3000M - Manifold mount variant of the M3000

Note.

The M3000 pump range utilizes high performance, efficient sensorless brushless motor technology.

These motors require a separate controller to operate and TCS Micropumps offer the EQ range of controllers for this purpose.



Typical Applications

- Medical devices
- Fuel Cells
- High Pressure Fuel Pump
- Cooling Systems
- Precision Flow
- Lubrication systems

Features

- High pressure capability
- High and low viscosity liquids
- Smooth almost pulseless flow
- CNC aluminium alloy construction
- Small size and lightweight
- 3 wire DC Sensorless Brushless Motor
- Solid structure

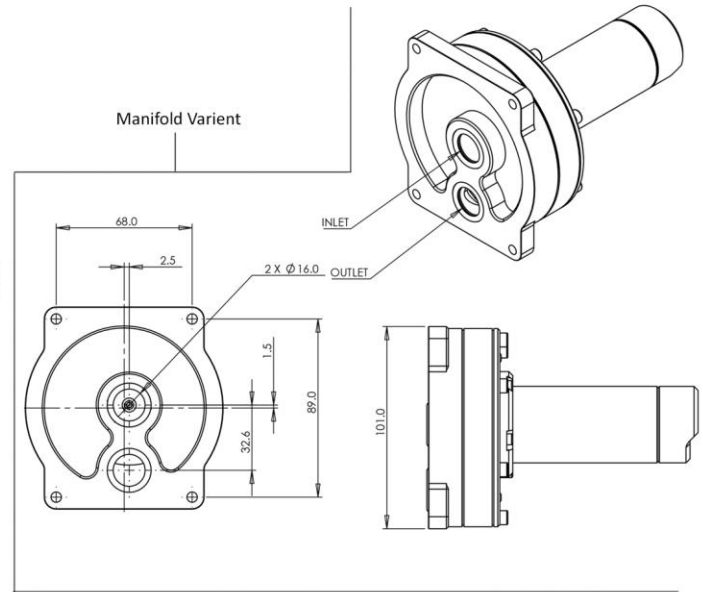
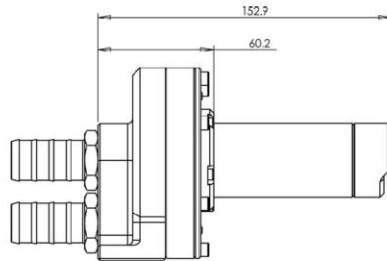
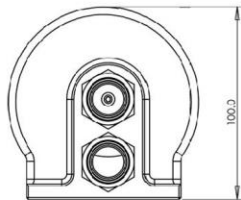
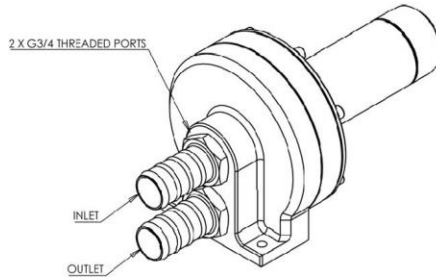
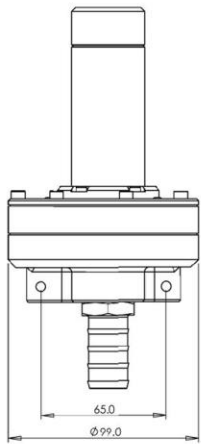

Materials

- Anodised 6000 Series Aluminum
- 316 Stainless Steel
- Viton
- Polyacetal
- Materials typical to a Brushless Motor

Performance Data

- Size 153 x 99 x 100 mm
- Weight 700g
- Operating Temp -20 to 100 deg c
- Smooth Pulseless Flow
- IP Rating - Standard pumps IP44
- Noise Levels 10dB
Measured at a distance of 1m with a 50dB ambient noise level
- Viscosity upto 20cst
- MTBF Stock Pumps 10,000 hrs
Special Variants available to order

