

DRAWING SHOWS INTERFACE DIMENSIONS.
THESE FEATURES SHOULD BE INCORPORATED
INTO YOUR OWN MANIFOLD DESIGN

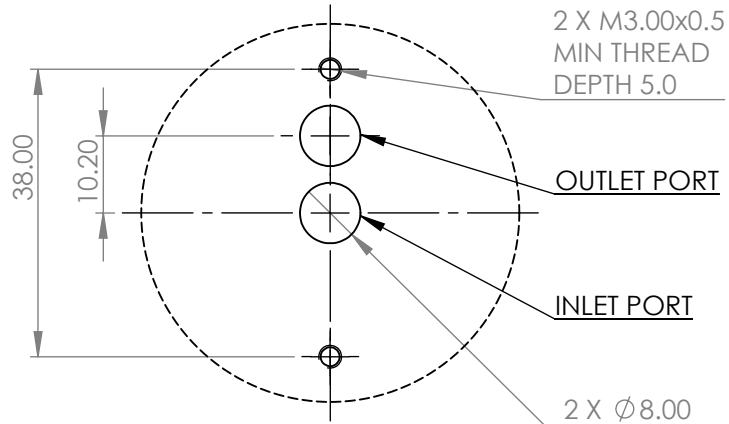

FACE SHOULD BE
SMOOTH AND FLAT TO
ENSURE A GOOD SEAL
WITH PUMP O-RINGS

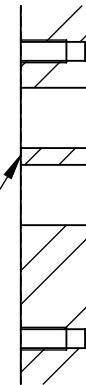

SECTION A-A

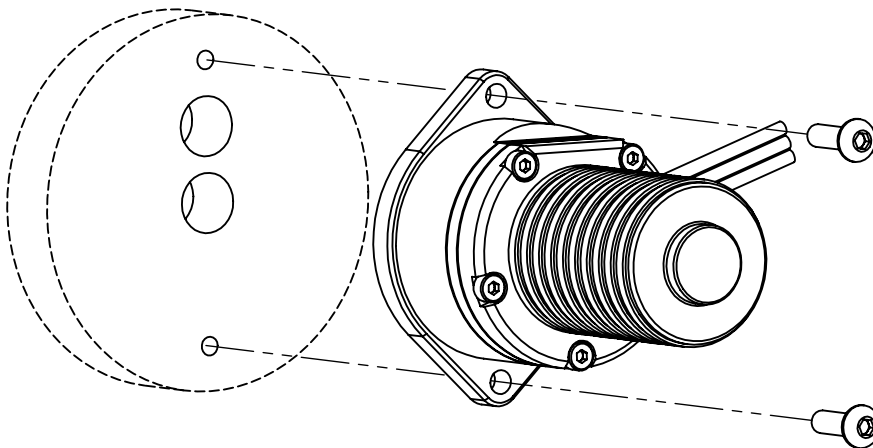

DESIGNED FOR USE WITH: -

2 X M3 FIXING SCREWS
2 X 8.0ID - 1.0 WALL O-RINGS
(SUPPLIED WITH THE PUMP)

REVISIONS

REV	DESCRIPTION	DRN	DATE
1	RELEASED TO PRODUCTION	IF	26/03/2014



TCS MICROPUMPS LTD - HIGHFIELD, FAVERSHAM ROAD,
OSPRINGE, KENT. ME13 OSF TEL (0)1795 539655

NOTES

MATERIAL NOT SPECIFIED

COATING N/A

FINISH ALL EXTERNAL FACES TO BE UNMARKED AND BLEMISH FREE

COLOUR N/A

STANDARD TOLLERANCES
APPLICABLE TO ALL DIMENSIONS ON THIS DRAWING UNLESS OTHERWISE STATED

WHOLE NUMBERS +/- 0.5
DECIMAL 1.0 +/- 0.1
DECIMAL 1.00 +/- 0.05

CRITICAL DIMENSIONS ARE SHOWN CIRCLED

THIS DRAWING IS THE PROPERTY OF TCS MICROPUMPS LTD. IT IS A CONFIDENTIAL DOCUMENT AND MUST NOT BE COPIED, USED OR ITS CONTENTS DIVULGED WITHOUT PRIOR WRITTEN CONSENT

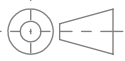

3RD ANGLE

A3 DIMENSIONS IN MM SCALE 1:1

DRAWN BY IF DATE 26/03/2014

CHECKED BY DATE

TITLE M500 Manifold Detail

DRG NO P-0308 SHEET NO 1 OF 1 REV 1